

Operating Instructions

Robotic Pool Cleaner ● Nettoyeur de Piscine ● Automatischer Schwimmbeckenreiniger
Robot di Pulizia per Piscine ● Limpiafondos de Piscina ● Aspirador Automático de Piscina



BLUE PEARL

- | | | |
|-----------|----|---|
| English | ① | Operating Instructions and Parts List |
| Français | ⑨ | Mise en marche de votre robot nettoyeur de piscine |
| Deutsch | ⑰ | Bedienungsanleitung für den automatischen Bodensauger |
| Italiano | ⑳ | Funzionamento del nuovo robot di pulizia per piscine |
| Español | ③③ | Manejo de Limpiafondos de Piscina |
| Português | ④① | Manual de instruções |



ENGLISH

Dear Customer,
Thank you for choosing our product to clean your pool. We hope that you will enjoy using your new robot to maintain your swimming pool for years to come.
Before you begin to use your robot, please take a few minutes to carefully read these operating instructions.
Again, thank you for choosing our product.

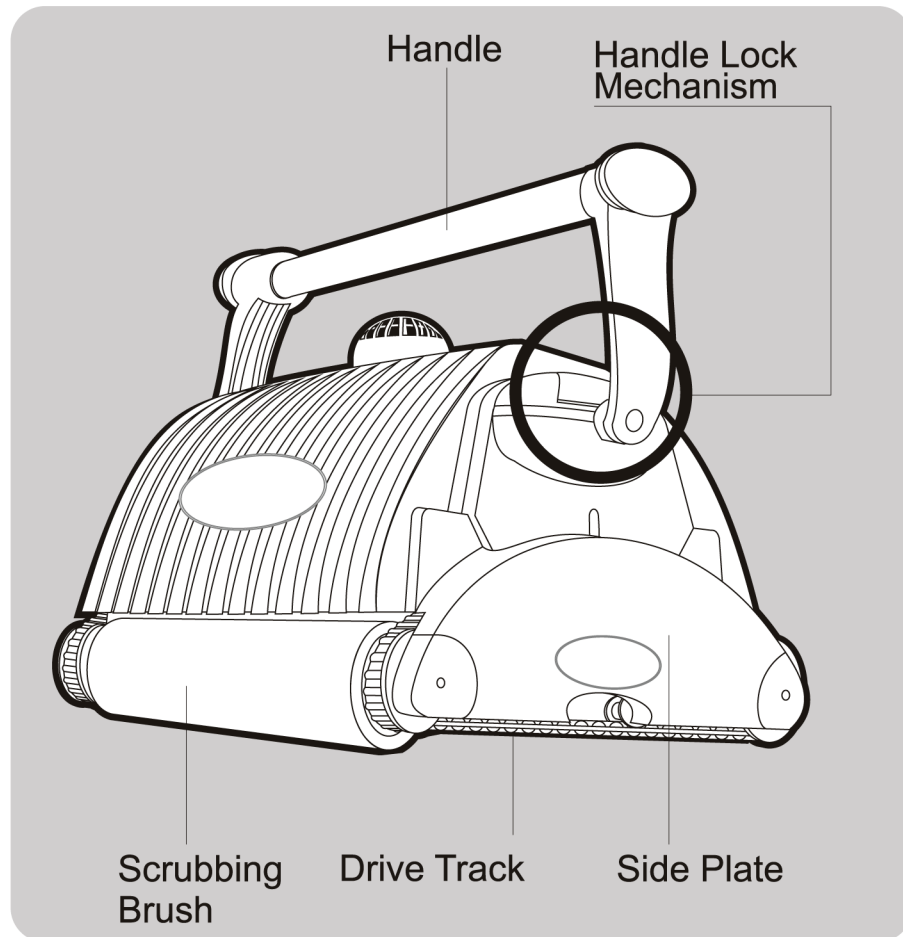

IMPORTANT

CAUTION: Do not switch the pool cleaner “ON” if it is not fully immersed in water. Operating the cleaner out of water will cause severe damage immediately and will result in loss of warranty.

Allow the cleaner to remain in the pool for 15 to 20 minutes following the end of its cleaning cycle. This will allow the motors to cool adequately. Do not leave the cleaner in the pool all the time. Always remember to turn the power supply “OFF” and unplug it from the power outlet before removing the cleaner from the pool.

WARNING: Your Cleaner should not be used while people are swimming in the pool.

Safety Note

- The unit must be supplied through a residual current device (RCD) having a rated residual operating current not exceeding 30 mA
- The connection to the branch circuit should be consistent with the local and national wiring rules (electrical code).
- Mishandling of the unit can result in leakage of lubricants.
- If the supply cord is damaged, it must be replaced by the manufacturer’s service agent or a qualified and trained person in order to avoid hazards.

Operating the Pool Cleaner

Your new automatic pool cleaner contains:

- The robotic pool cleaner with its floating cable.
- The Power Supply (transformer).
- Cart (optional)

Please read this manual completely before operating your pool cleaner.

- Place the power supply (transformer) at least three meters / ten feet from the pool.(fig.1). The transformer will supply low voltage to the cleaner.
- Uncoil the cable.(fig.1a)
- For proper operation, lock the moveable handle diagonally across the top of the cleaner's body. Push down on the handle lock mechanism and slide the handle all the way to the end (recommended one slot before the end), then release the lock. The handle will remain fixed in this position. Repeat this process on the other side of the cleaner. Remember, the handle must be fixed diagonally (fig.2a, 2b)
- Place the unit in the water. Turn the unit side to side in the water to allow air to escape from the body and then let the cleaner sink to the bottom of the pool (fig.3). Then, spread the cable over the surface of the pool as evenly as possible (fig.1).
- Plug the cable into the power supply. Make sure the key on the plug exactly corresponds with the key slot on the socket of the power supply (fig.1b). Plug the power supply into a grounded outlet. Ensure that the electric outlet has been properly grounded (fig.1c). The light will glow indicating that the system is " ON " and the pool cleaner will start the cleaning cycle. The unit keeps record of the number of cleaning cycles. Only an authorized service center can display the accumulated cleaning cycles. (See details on the next page)

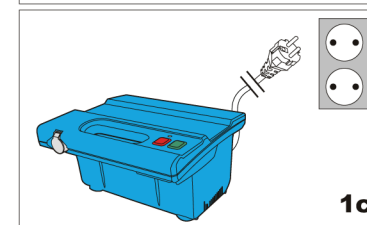
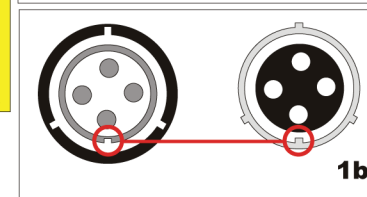
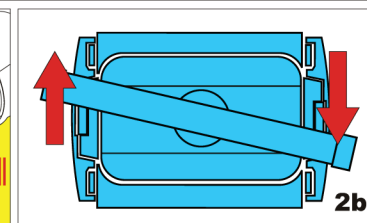
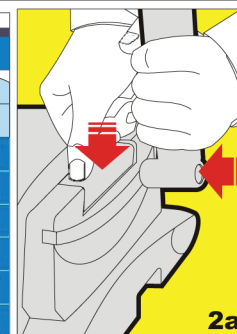
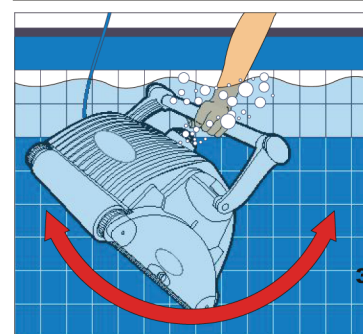
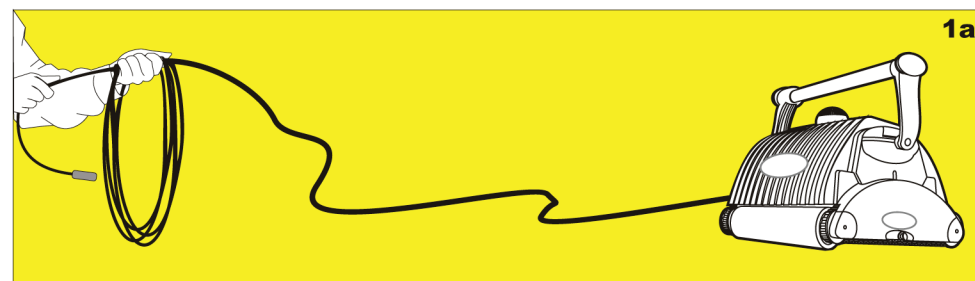
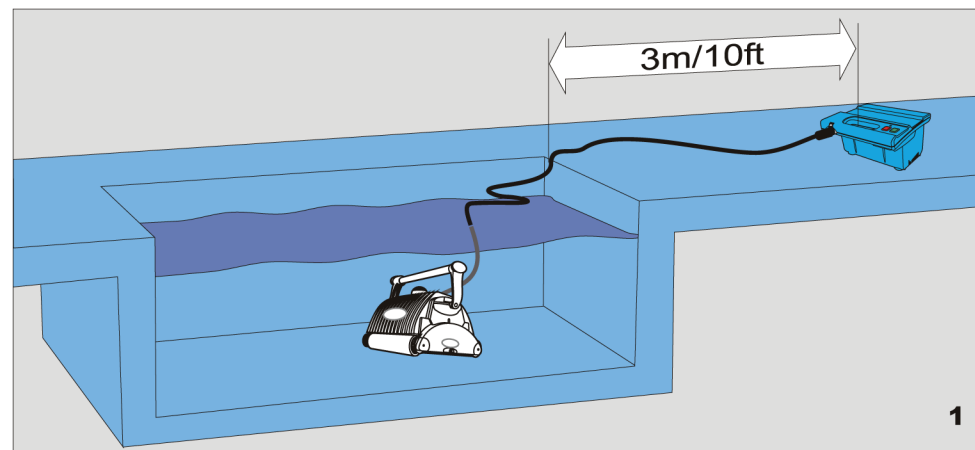

WARNING: A Ground Fault Current Interrupter (GFCI-USA) or a Residual Current Device (RCD-EUROPE) must be installed to protect your electric outlet and prevent any possible electric shock.

Power Supply - Operating Instructions

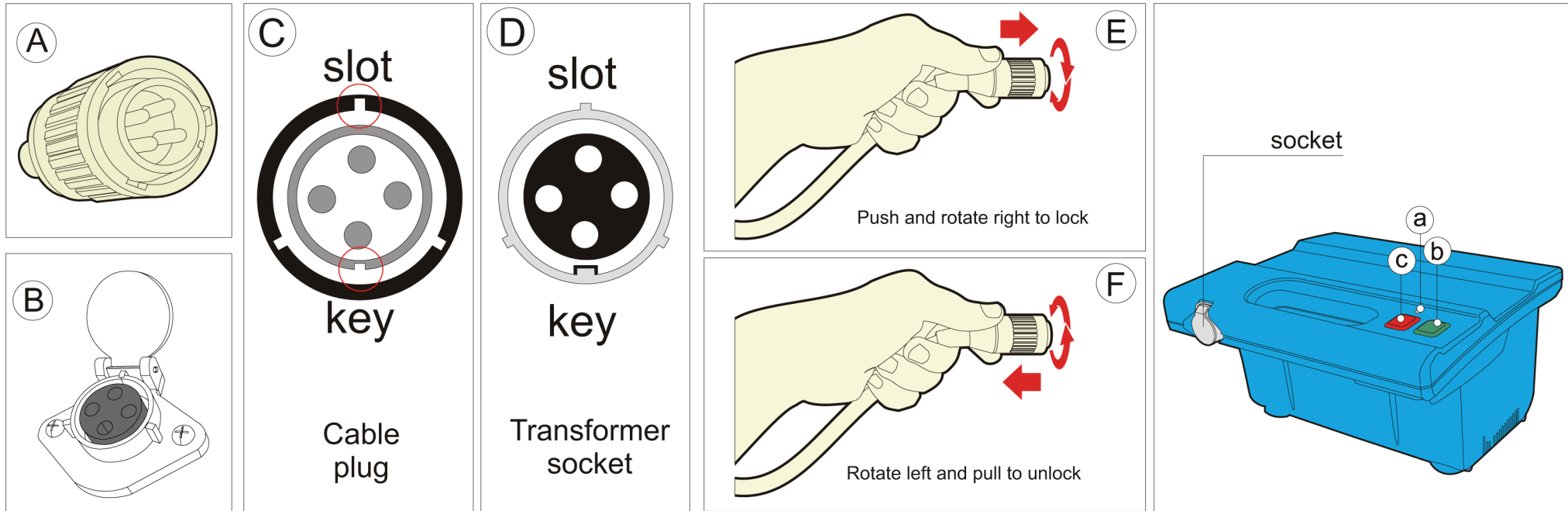

To plug the cable (Fig A) into the socket on the power supply (Fig B), please do the following:

1. Prepare the plug as seen in (Fig. C) with the key and 3 outside slots exactly as shown.
2. Fit exactly the key and the slots from cable plug with the corresponding key and slots from the transformer socket. (Fig. D)
3. Push the plug into the socket of the transformer all the way in.
4. Once the plug is in, rotate the plug to the right to lock it into place (Fig. E).
5. To remove the plug, first rotate the plug to the left to unlock it, then pull it out (Fig. F).

- a. **Light** indicates that the machine is running.
- b. **Green** push button turns the machine "ON".
- c. **Red** push button turns the machine "OFF".

IMPORTANT- After every cycle the pool cleaner will turn off automatically . In case you want to turn the machine off during the working cycle, push the **red button** once and the **indicator light** will turn off, indicating that the machine has stopped running.

Maintenance and adjustment

CLEAN THE FILTER BAG AFTER EVERY CLEANING CYCLE

- a. Unplug the power supply. (Please keep the plug away from contact with water)
- b. If the unit is in the pool, gently pull the cleaner toward you using the cable until the handle is within reach. Use the handle (not the cable) to pull the cleaner out of the pool after allowing most of the water to drain from the unit.
- c. Lay the unit on its back on a smooth surface (in order to prevent scratches on the machine body), release the lock tabs and remove the bottom lid assembly. (fig.4a, 4b, 4c, 4d)
- d. Remove the filter bag from the support bars, turn it inside out and wash off all the dirt with a garden hose or in a sink. Squeeze the bag gently until the rinse water is clear. If necessary, machine wash the bag using only cold water with **NO DETERGENT!** (fig.5)
- e. Re-install the bag on the support bars with the **label** in the center of one of the long sides of the bottom lid (5a)
- f. Re-install the bottom lid assembly in the body. Push down on it until lock tabs will snap into place properly.



IMPORTANT TIPS:

- Shut off and unplug the power supply every time you remove the cleaner from the water.
- Clean the filter bag after every cycle.
- Reverse the handle after every cleaning cycle to avoid tangling the cable.
- Periodically straighten out the floating cable.
- Replace worn brushes to ensure maximum cleaning performance
- Make sure that your pool cleaner positions itself properly on the wall. The machine handle must rest parallel to the water line upon reaching the surface of the water.
- Save your cleaner's packaging for off-season storage or for shipping the unit to your dealer if service is required.
- Leave your pool cleaner in the water for 15 to 20 minutes after every cleaning cycle.
- **Do not leave your cleaner in direct sunlight when not in use.**
- **Never leave the power supply in direct sunlight and avoid leaving it in the rain.**
- Occasionally, you should rinse your cleaner in clean, fresh water. This will lengthen the service life of the drive belts, drive tracks and scrubbing brushes.
- **Clean the propeller once a month**
(see next page for details)

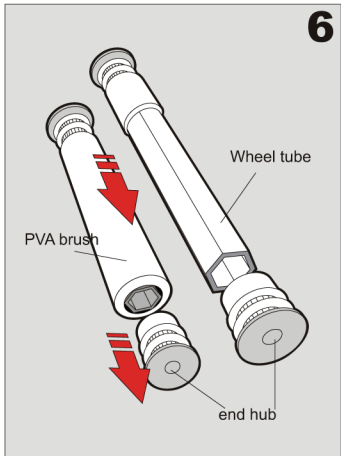

6

CHANGING BRUSHES

Depending upon how frequently you use the cleaner pool cleaner, it will be necessary to replace the brushes when they are worn out. Worn out brushes will impede cleaner's scrubbing, climbing the walls or general performance.

- a. Detach one of the side plates, unscrewing the four screws (see fig.7a).
- b. With side plate detached, take out the wheel tube from the machine.
- c. Open the end hub and pull out the worn PVA brush.(see fig.6)
- d. Place the new PVA brush on to the hexagonal tube and close it with the end hub.
- e. Reinstall the wheel tube in place and place back the side plate screwing back the four screws.

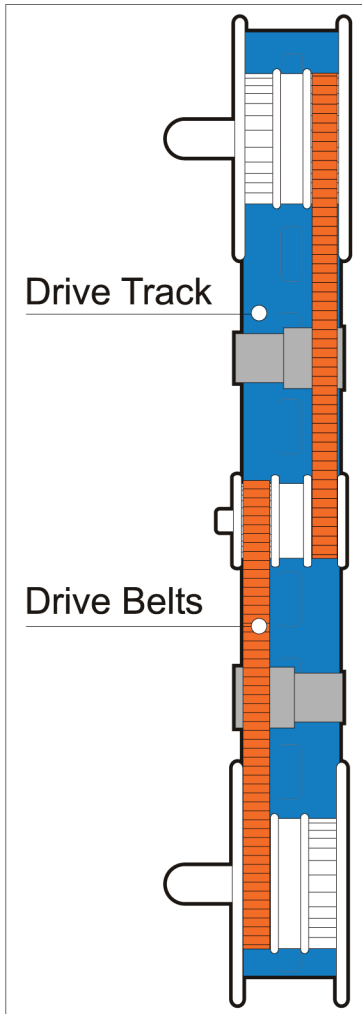
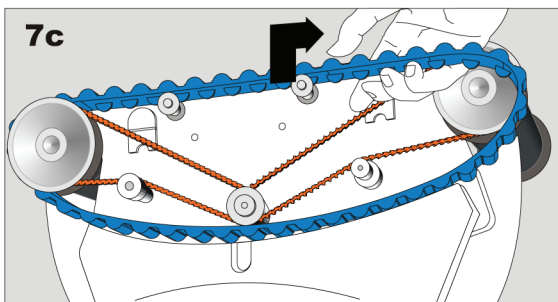
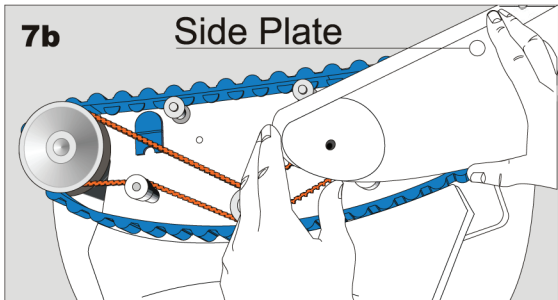
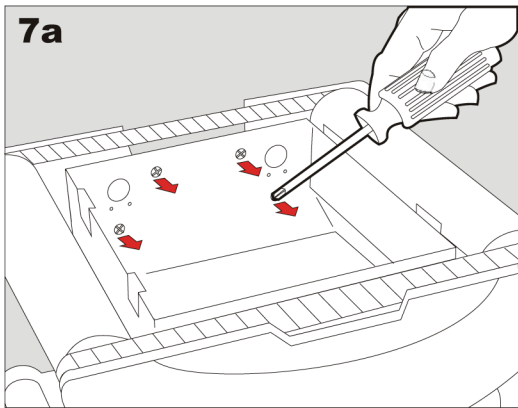

PVA BRUSHES CARE:

This special brush material is most efficient when wet. Any discoloration is normal in the drying process when exposed to open air. Please allow brushes to absorb pool water for about 20 minutes before initial use or at first use of every season. You will notice that as the brushes absorb the water and start scrubbing your pool, the discoloration will disappear.

CHANGING THE DRIVE BELTS

Depending on usage, the drive belts (located behind the side plate) will stretch. When this happens, in order to maintain the optimum performance of the unit, these drive belts have to be changed.

- a) Turn the robot upside down and remove the bottom lid assembly (fig. 4a,4b,4c,4d).
 - b) Inside, locate 4 screws on drive motor side, which hold the side plate in place (fig. 7a, 7b).
 - c) Take out these screws and remove the side plate
 - d) Remove the drive track. Before removing the drive track, notice carefully how the drive belts are positioned for re-assembly (fig. 7c).
 - e) Take out the old drive belts and replace them with new ones.
- To re-assemble, reverse steps d to a.

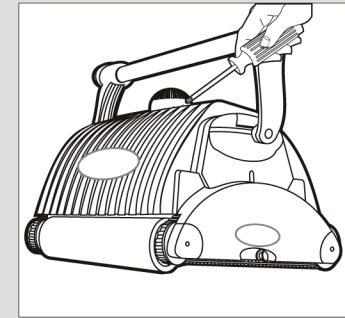
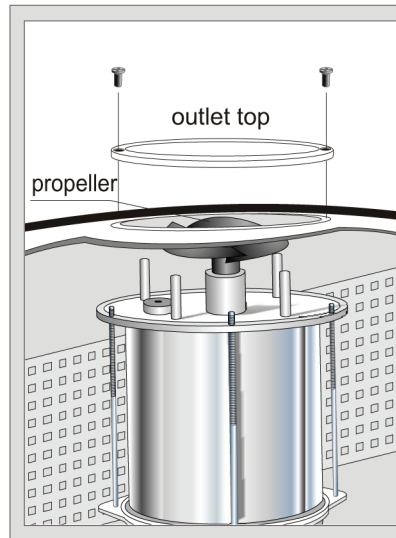

Cleaning the pump propeller:

- 1) Take out the 2 (4) screws from the outlet top
- 2) Take out the outlet top and remove hair and other debris around propeller

CAUTION:

To avoid scratches and other blemishes appearing on your robot, simply find a smooth surface for it to rest on when cleaning the debris bag or performing minor adjustments. These scratches could produce changes in the robots soft and smooth edges resulting in potential damage to some flexible pool surfaces.

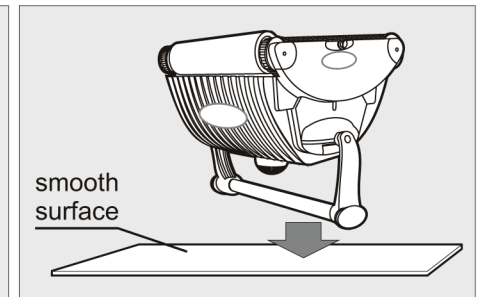
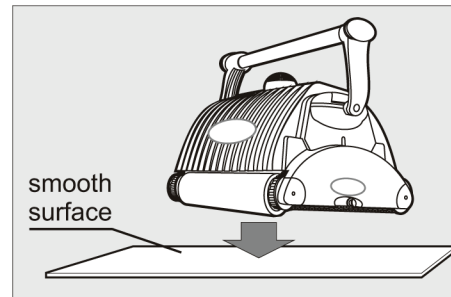

Troubleshooting Guide

PLEASE CHECK THE FOLLOWING BEFORE CALLING YOUR SERVICE CENTER

Before troubleshooting, the pool cleaner must be disconnected from the power supply and the power supply must be unplugged from the electrical outlet to prevent damage to the unit and possible personal injury.

For reference numbers, consult the parts list diagram located on the last page of the instructions.

Problems	Things to check
<p>1. Unit does not pump water or move:</p>	<ul style="list-style-type: none"> a) Check to see if electric outlet (22) has power. b) Check if transformer (16) is plugged into a grounded outlet and the blue cable assembly is plugged into the transformer.* c) Switch the power supply “OFF” (19) and “ON” (21) buttons a few times. Allow 45 seconds between “ON” and “OFF”. d) Check for and remove any debris such as hair, string, or leaves that may be obstructing the free movement of the Drive Pulley (5), Drive Belts (6) , or Drive Tracks (7) . e) Check that the Drive Belts (6) and Drive Tracks (7) are properly aligned and are taut. Adjust or replace if necessary.
<p>2. Unit does not pump water at all, or pumps slowly but moves:</p>	<ul style="list-style-type: none"> a) Check to see if propeller (1) is seized due to accumulation of hair or debris on the propellers. Remove the top screws on each outlet top (1) and clean the propeller. When reassembling the top cover, do not overtighten the screws. b) Check to see if the filter bag (12) is thoroughly clean. Clean as necessary. c) If a and b are negative, check the pump motors (2). If they are not functioning send the unit to your service center.

*The transformer cord can only be replaced with the aid of special purpose tools normally available only to authorized dealers, distributors and service centers.

Problems	Things to check
<p>3. Unit does not move but does pump water:</p>	<ul style="list-style-type: none">a) Check to see if forward/reverse motion is obstructed by foreign matter; hair, debris, etc. on drive belts (6) or drive tracks (7) or there is an entanglement with the power cord. Clean as necessary.b) Check if drive belts (6) have slipped out of place. Also check for proper tension of drive belts (6). If necessary replace belts.c) Check for loose drive motor (3) connections.d) If a, b, and c are negative, check the Master and Slave motors. If one or the other is not functioning, send the unit to your service center.
<p>4. Unit does not pick up dirt and debris:</p>	<ul style="list-style-type: none">a) Check 2a and 2b of this guide.b) Check the Intake Valve Flaps (23) on the underside of your unit. The Flaps should move freely to open and close. Clean and free the Valve Flaps (23) if necessary.
<p>5. Unit does not seem to cover the entire pool:</p>	<ul style="list-style-type: none">a) Most likely a thorough cleaning of the filter bag (12) is needed.b) Check to see that the blue cable (15) is properly spread out and is untangled.c) Allow the unit to run in the pool for the entire cleaning cycle.d) Make sure that the Floating Handle (14) is locked diagonally across the top of your unit's body.e) Check that the Pump Motor (2) is operating. Please refer to the Troubleshooting section titled “Moves But Does Not Pick Up Dirt And Debris”f) After following all of the above, if there is still a problem, call your dealer for specific additional assistance.

Problems	Things to check
<p>6. Remote control (optional) does not operate properly:</p>	<ul style="list-style-type: none"> a) Check the battery in the Remote Control Transmitter (25), replace if necessary. b) Make sure that you activate the RC System (25) no more than 30 meters away from the Transformer, pointing the control box to the antenna. c) If there is still a problem with the RC System (25), call your service center for assistance.
<p>7. Debris Comes Out Of The Aquabot When Removing It From Pool (Bottom Lid Does Not Close Properly)</p>	<ul style="list-style-type: none"> a) Lock Tab (24)s -Check that the Lock Tabs (24) are not warped. They should be straight and aligned with the unit's body. b) Intake Valves (23) - Check that the Intake Valve Flaps on the underside of your unit (in the Bottom Lid) move freely to open and close. Clean Flaps if necessary.
<p>8. The cable is twisted:</p>	<ul style="list-style-type: none"> a) Reverse the diagonal position of the handle. b) Use the E-Z swivel as shown bellow.

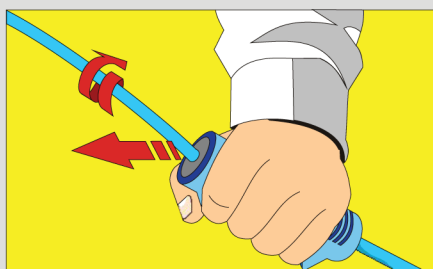
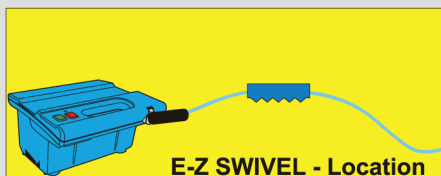

Holding with one hand the E-Z Swivel.

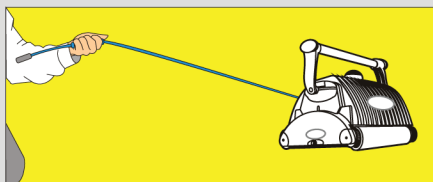
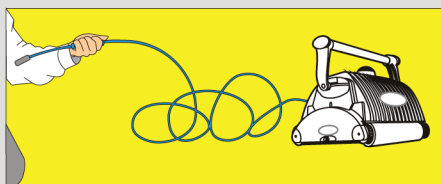

The core will rotate inside the cover and in this way will untangle the cable.

Place the Robot on the ground and unplug the cable from the transformer. With one hand, holding the E-Z Swivel, walk away from the Robot, pulling the cable to its full length.

CABLE CARE

The cable may become twisted after a period of time in use. To correct this condition, simply lock the moveable handle on the top of the cleaner in the opposite diagonal direction. The pool cleaner will now travel in the opposite direction while cleaning your pool and the cable will uncoil. Check the cable periodically for external damage. If the problem persists, use the E-Z Swivel device.

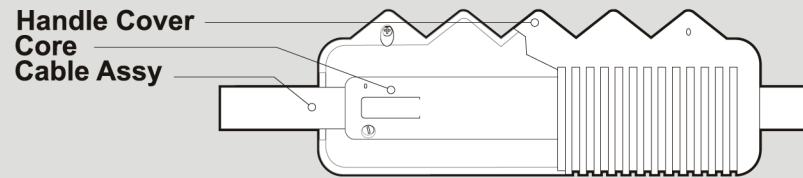

patent pending

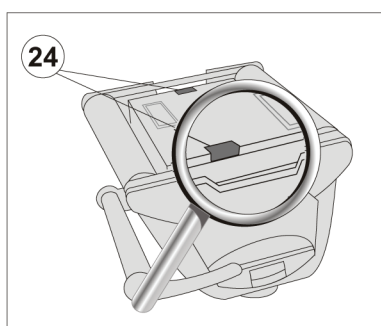
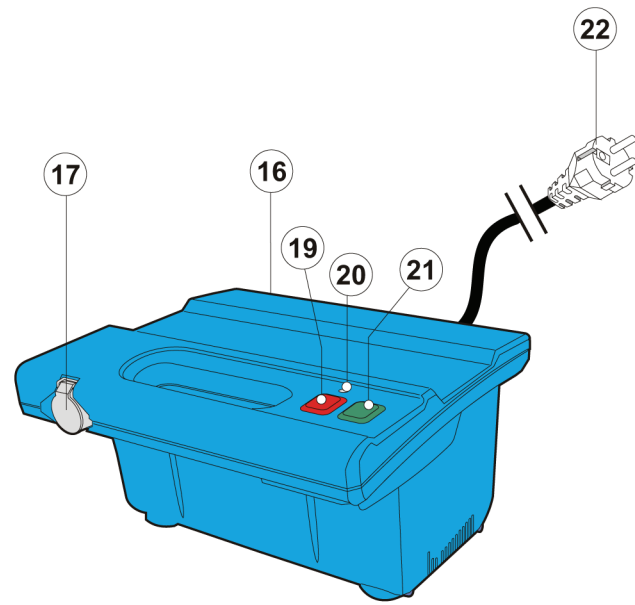
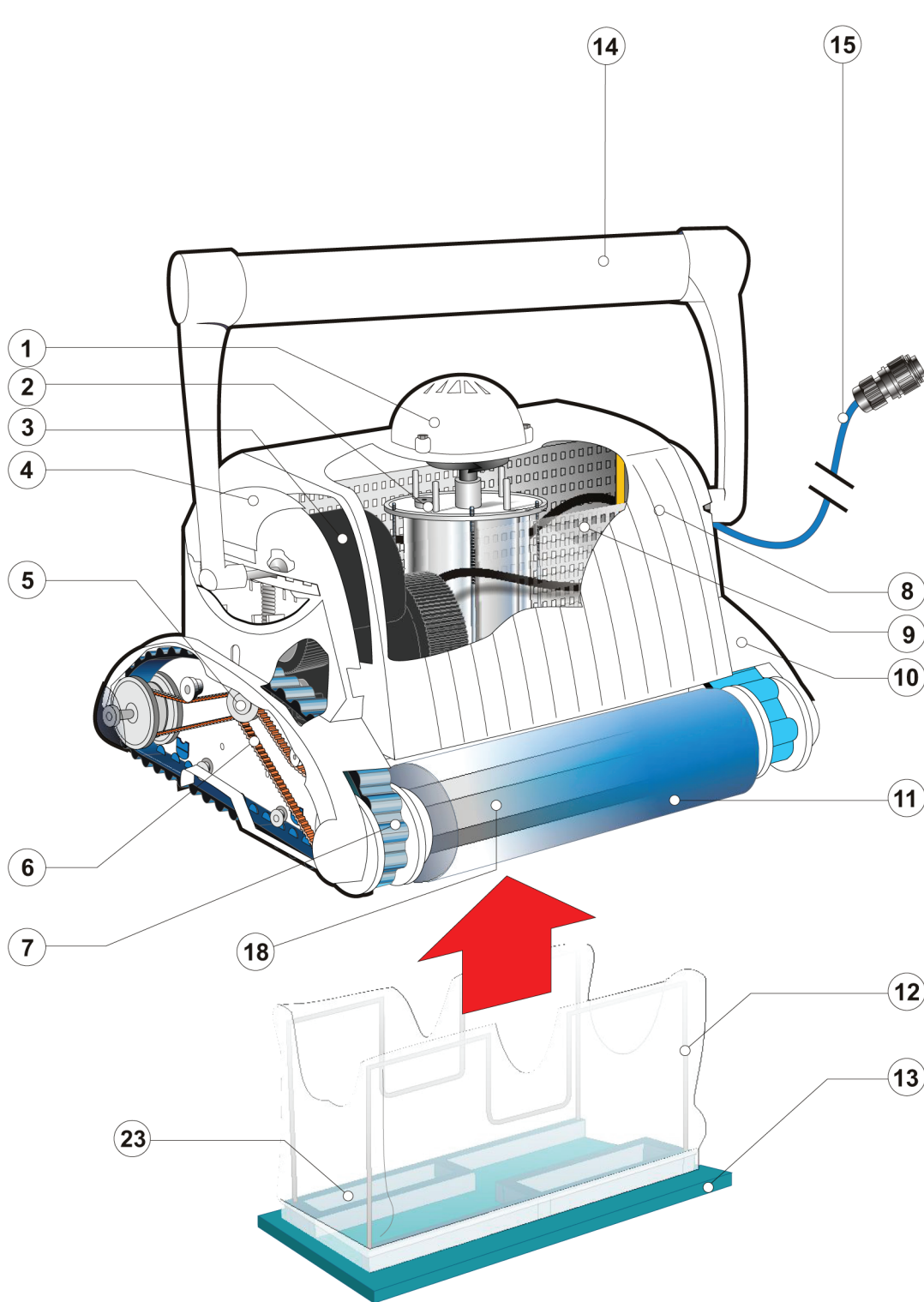

Parts List

1. Outlet Top and propeller
2. Pump Motor
3. Drive Motor
4. Handle Locking Bracket
5. Pulley Assembly
6. Drive Belt
7. Drive Track
8. Body Assembly
9. Filter Screen
10. Side Plate
11. PVA Brushes
12. Filter Bag
13. Bottom Lid Assembly
14. Handle Assembly
15. Cable Assembly
16. Power Supply (Transformer)
17. Transformer Socket
18. Wheel Tube Assembly
19. "OFF" button
20. LED
21. "ON" button
22. Power Cord (Outlet)
23. Intake Valve Flaps.
24. Lock Tabs