

EC-AG1, EC-AG2, & EC-AG1-25

**Corona Discharge Ozone Generators
for Above Ground Pools**

INSTALLATION & OPERATION MANUAL

DEL  ozone™
EPA Estab. No. 071472-CA-001



DEL  ozone™

PO Box 4509, San Luis Obispo, Ca. 93401
800.676.1335
www.delozone.com

IMPORTANT SAFETY INSTRUCTIONS

2

1. Read and Follow All Instructions
2. Read this manual completely before attempting installation.
3. All permanent electrical connections should be made by a qualified electrician.
4. Connect to a grounding type receptacle only. If the ozone generator electrical connection is to be attached to the pool controls, be sure the pool controls are protected by a Ground Fault Circuit Interrupter (G.F.C.I.). If the ozone generator is connected to an independent electrical supply, then a G.F.C.I. must be installed between the ozone generator and the electrical supply.
5. Do not bury cord.
6. Warning - To reduce the risk of electrical shock, replace damaged cord immediately.
7. Install at least 5 feet (1.5 meters) from wall of pool. Install ozone generator no less than one (1) foot above maximum water level to prevent water from contacting electrical equipment. Install in accordance with the installation instructions.
8. Follow all applicable electrical codes.
9. Electric shock hazard. Be sure to turn power OFF and disconnect from power source before any service work is performed. Failure to do so could result in serious injury or death.
10. The ozone generator must be installed in an outdoor location, or indoors in a forced air ventilated room, and installed so that the orientation is exactly as shown in Figure 1.
11. Mount the ozone generator so that it is inaccessible to anyone in the pool. Never attempt any servicing while unit is wet.
12. Plastic ozone supply tubing is supplied with the ozone generator. Never replace this tubing with metal tubing.
13. Warning - Short-term inhalation of high concentrations of ozone and long term inhalation of low concentrations of ozone can cause serious harmful physiological effects. DO NOT inhale ozone gas produced by this device.
14. For your safety, do not store or use gasoline, chemicals or other flammable liquids or vapors near this or any other appliance.

EC-AG1-25



EC-AG1, EC-AG2



SAVE THESE INSTRUCTIONS.

After this information is provided, DEL Ozone will release a RETURN GOODS AUTHORIZATION (RGA) NUMBER. After receiving the RGA number the part in question must be returned to DEL Ozone, freight prepaid, with the RGA number clearly marked on the outside of the package. All preauthorized defective parts must be returned to DEL Ozone within thirty (30) days. Under no circumstances may any product be returned to DEL Ozone without prior authorization. You must call or write DEL Ozone prior to returning product or your returned goods shipment will be refused. Upon receipt of preauthorized returned goods, DEL Ozone will repair or replace, at DEL Ozone's option, the defective product(s) and return them freight (prepaid for products under warranty). Buyer's acceptance of the product and use thereof constitutes acceptance of these terms.

Table of Contents

SECTION 1

General Information

1A	Description	4
1B	Specifications	4
1C	Warranty Summary	4

SECTION 2

Installation

2A	Location	5
2B	Mounting	5
2C	Electrical	5
2D	Plumbing for Above Ground Pools	6

SECTION 3

Operation

3A	General	8
3B	Initial System Start-Up	8
3C	System Shut-Down	8

SECTION 4

Maintenance & Service

4A	System Electromechanical Overview	9
4B	System Maintenance	9
4C	Generator Servicing	10
4D	Trouble Shooting	12

Warranty		14
-----------------	--	-----------

SECTION 1 General Information

1A Description

The EC-AG ozone generators described in this manual are designed to provide the benefits of ozonated water in an environmentally safe and effective manner. The high quality, specially engineered components ensure efficient ozone output and reliable performance. As a result of proper use of the ozone generators, unpleasant effects of traditional chemical use are virtually eliminated. The ozone generators are safe and harmless to your equipment when installed properly.

1B Specifications

Flow rate:

15 scfh (nominal)

Flow rate and ozone output will vary with installation.

Power Requirements:

- EC-AG1: 120V, 60 Hz, 1Ø, 0.10 Amp
- EC-AG2: 120V, 60 Hz, 1Ø, 0.05 Amp
- EC-AG1-25: 230V, 50 Hz, 1Ø, 0.05 Amp

Shipping Weight:

- EC-AG1: Approx. 4.8 pounds / 2.2 kg
- EC-AG2: Approx. 4.8 pounds / 2.2 kg
- EC-AG1-25: Approx. 5.5 pounds / 2.5 kg

1C Warranty Summary

Limited Warranty:

1 year warranty on entire generator. See Warranty section for limitations and details on obtaining warranty service.

Location Requirements:

Mounting: Wall mount in a clean, protected area.
Ambient Temp: 30°F - 120°F (0°C - 50°C)

LIMITED ONE YEAR WARRANTY

The limited warranty set forth below applies to products manufactured by DEL Ozone - and sold by DEL Ozone or its authorized dealers. This limited warranty is given only to the first retail purchaser of such products and is not transferable to any subsequent owners or purchasers of such products.

DEL Ozone warrants that it or its authorized dealers will repair or replace, at its option, any part of such products proven to be defective in materials or workmanship within ONE (1) year from the date of retail purchase of such products. (All parts) ANY REPAIR OR REPLACEMENT WILL BE WARRANTED ONLY FOR THE BALANCE OF THE ORIGINAL WARRANTY PERIOD. NOTE: USE ONLY DEL Ozone AUTHORIZED REPLACEMENT PARTS. USE OF ANY OTHER PART(S) WILL AUTOMATICALLY VOID THIS WARRANTY.

THIS LIMITED WARRANTY DOES NOT INCLUDE ANY OF THE FOLLOWING:
(a) any labor charges for troubleshooting, removal, or installation of such parts; (b) any repair or replacement of such parts necessitated by faulty installation, improper maintenance, improper operation, misuse, abuse, negligence, accident, fire, repair materials, and/or unauthorized accessories; (c) any such products installed without regard to required local codes and accepted trade practices; (d) ANY IMPLIED WARRANTY OF MERCHANTABILITY OR IMPLIED WARRANTY OF FITNESS FOR PARTICULAR PURPOSE, AND SUCH WARRANTIES ARE HEREBY DISCLAIMED: AND (e) DEL Ozone SHALL NOT BE LIABLE UNDER ANY CIRCUMSTANCES FOR LOSS OF USE OF SUCH PRODUCTS, LOST PROFITS, DIRECT DAMAGES, INDIRECT DAMAGES, CONSEQUENTIAL DAMAGES AND/OR INCIDENTAL DAMAGES.

TO OBTAIN WARRANTY SERVICE

Contact DEL Ozone: PO Box 4509, San Luis Obispo, CA 93401, 805.541.1601

When filing a claim, you must provide:

1. your name, mailing address and telephone number
2. the selling dealer's name
3. proof of date of purchase
4. the date of failure
5. a description of the failure

11. Connect CD electrode to power supply connector.
12. Slide cover into position while lifting the base of the cover up.
13. Lower cover over CD electrode and snap cover tabs into place.
14. Replace cover Screw
15. Reinstall the EC-AGX into the original mounting location; reconnect ozone supply tubing to hose barb and reconnect the power cord.

4D. Trouble Shooting

Knowledge of electrical applications is required for trouble shooting. Contact a certified electrician if you are unsure of your ability to service the equipment. Improper servicing will void the Warranty.

Symptom: No Flow.

1. Injector not supplying adequate suction.
 - a. Check pump and ensure water is flowing through injector.
 - b. Check that pump skimmer and filter are clean.
 - c. Check that injector is plumbed in the right direction.
 - d. Ensure that there is no debris clogged inside the injector.
2. Tubing is impaired.
 - a. Check for kinks or clogs.
 - b. Check for cracks or cuts.
 - c. Check connections.
 - d. Check that the check valve is installed with the arrow pointing towards the injector.
 - e. Be sure that the check valve has not become fouled with debris. Disconnect the ozone tubing from the injector. With the pump running, test the end of the hose barb with your thumb, and feel for suction. Wash your hands immediately afterwards to remove any residual nitric acid. If there is sufficient suction without the check valve, replace the check valve and tubing.

Symptom: Ozone tubing becomes yellow/brown and brittle.

1. The high concentration of ozone created by the corona discharge ozone generators, as well as environmental conditions like UV sunlight will tend to deteriorate the supplied ozone tubing. This is normal and acceptable, as long as the tubing doesn't become cracked and leak. Because of this, DEL recommends replacing the ozone supply tubing and your check valve every year.

SECTION 2 Installation

2A Location

The ozone generator units are designed for wall mounting. See Figure 1. Mount generator in a clean, protected area, either indoors or outdoors (preferably out of direct sunlight). Locate generator out of reach of sprinklers or drainage spouts. Allow sufficient access for maintenance and all tubing and electrical wires. Ozone generator should be installed at least (not less than) one foot above the maximum water level. See Section 2D-2, Ozone Gas Line, for plumbing instructions based on mounting location.

2B Wall Mounting

1. Refer to Figure 1 to mark the locations for the two mounting screws.
2. Install screws (or other hardware appropriate for mounting surface) through the two mounting holes built in to the base of the EC-AG ozone system.

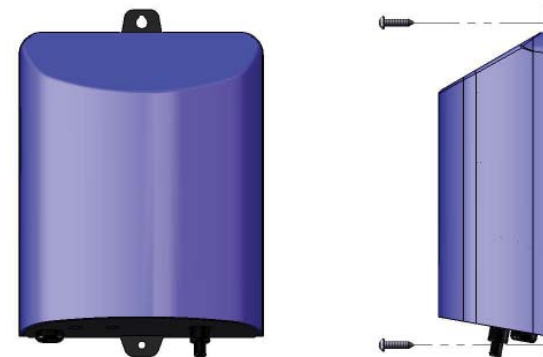

Figure 1 Wall Mount

2C Electrical

2C-1. Main Power: Connect the ozone generator to the pool timing clock so that the ozone generator operates simultaneously with the pool pump. The circuit must be protected by a ground-fault circuit interrupter (GFCI) installed in accordance to electrical code. Refer to the IMPORTANT SAFETY INSTRUCTIONS at the beginning of this manual for important wiring information.

If the EC-AG power cord comes with a built-in receptacle and the pump is equipped with a standard plug (NEMA 5-15P), the pump may be plugged in on top of the EC-AG cord (pump current must not exceed 15A). Plug must be protected from moisture.

2D Plumbing

Ozone gas is introduced to the pool circulation line using a venturi injector. Suction developed by the venturi allows the ozone generator to operate safely under vacuum.

Note: The injector needs to be installed after all other equipment or possible failure may occur.

2D-1. Plumbing the Above Ground Injector Assembly

1. Wrap Teflon tape on all male pipe threads.
2. Disconnect the pool's return hose from the pool at the point where the tubing returns into the pool. Keep the hose elevated to prevent pool from draining through pump and filter.
3. Screw 1-1/2" nipple loosely into 1-1/2" elbow, then screw this assembly into the pool's 1-1/2" eye ball fitting stopping when tight and elbow is pointed down (Figure 2).
4. Screw the Venturi Injector into the elbow. NOTE: Make sure the injector is installed with the flow arrow pointed in the direction of water flow and with the Ozone port accessible.
5. Connect the pool's return hose to the bottom (inlet) of the injector using 1-1/2" flex hose barb and the stainless steel hose clamp.
6. Attach Hose Barb Fitting to Ozone Port on Injector (See Figure 2a or Figure 2b).

CD Ozone System

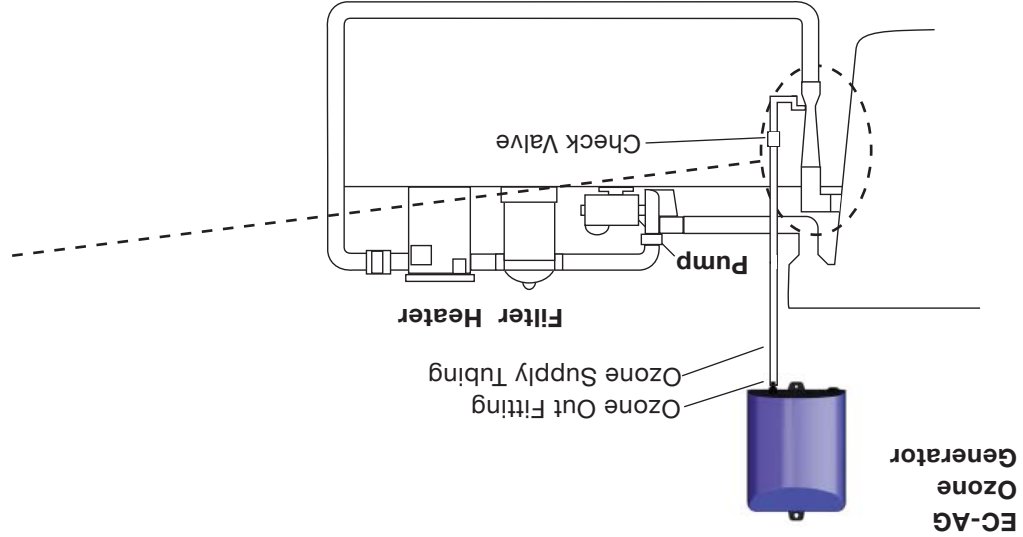

Figure 2 Installation Schematic for Injector Assembly

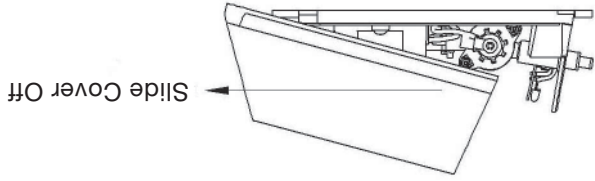

Figure 5 Sliding cover off

4. Slide the cover forward and off.

4C-3. Ozone Module Replacement

1. Open the ozone generator as described in section 4C-2.

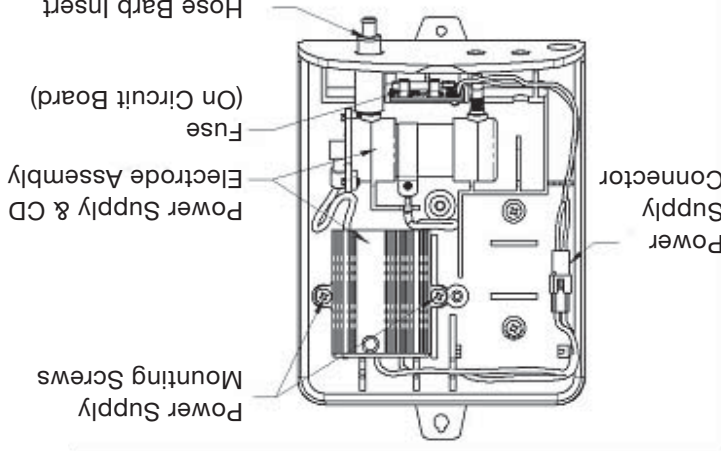

Figure 6 Internal component locations

2. Remove the power supply mounting screws.
3. Disconnect power supply connector (red & black wires).
4. Lift CD electrode up and out of hose barb insert (o-ring and hose barb insert may remain attached to electrode).
5. Carefully pull circuit board vertically out of base slot & remove old fuse.
6. Insert new fuse and carefully push circuit board back into base seat.
7. Insert new hose barb insert making sure to align the hose barb correctly and insert it completely into its slotted hole.
8. Install power supply and mounting screws. Route power supply wires through pegs.
9. Place new o-ring onto CD electrode outlet (reference old electrode location).
10. Install CD electrode by inserting into hose barb and gently pushing into cradle.

4C Generator Servicing

4C-1. The ozone generator must be removed from the wall before servicing. To remove the ozone generator:

1. Disconnect service to ozone generator.
2. Disconnect the power cord from the pool timer circuit.
3. Disconnect the ozone supply tubing from the bottom end cap of the ozone generator.
4. Remove the two wall mounting screws.

4C-2. Opening the ozone generator

The ozone generator enclosure consists of two plastic parts that clip together. They are held in place by one screw. To open the enclosure:

1. Remove the cover screw on the back side of the base of the EC-AGX (Figure 3).

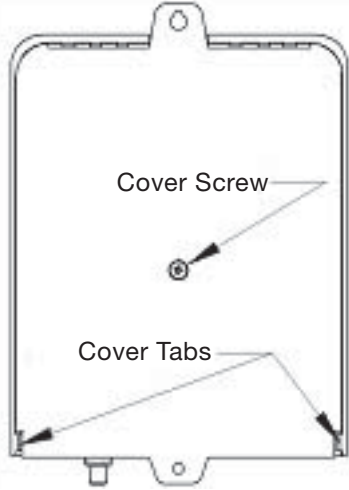

Figure 3 Cover screw and tabs

2. Using a flat head screwdriver or fingers, pry the two cover tabs outward to release the cover from the base.

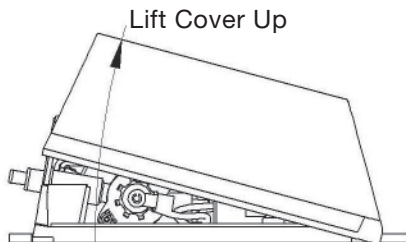

Figure 4 Lifting Cover

3. Lift the cover up (Figure 4).

2D-2. Ozone Gas Line

Connect the end of the Ozone Supply Tubing that is closest to the Check Valve to the Hose Barb Fitting on the Injector. Secure with a supplied hose clamp.

If the generator is mounted above the water line attach the other end of the Ozone Supply Tubing to the ozone out fitting on the EC-AG and secure with the supplied hose clamps.

If the generator is mounted below the water line, the ozone supply tubing must be run to a point above the water line. Simply coil the tubing into a complete circle about 6" diameter and fasten it above the water line. This will act as a water trap to prevent water from running back to the generator.

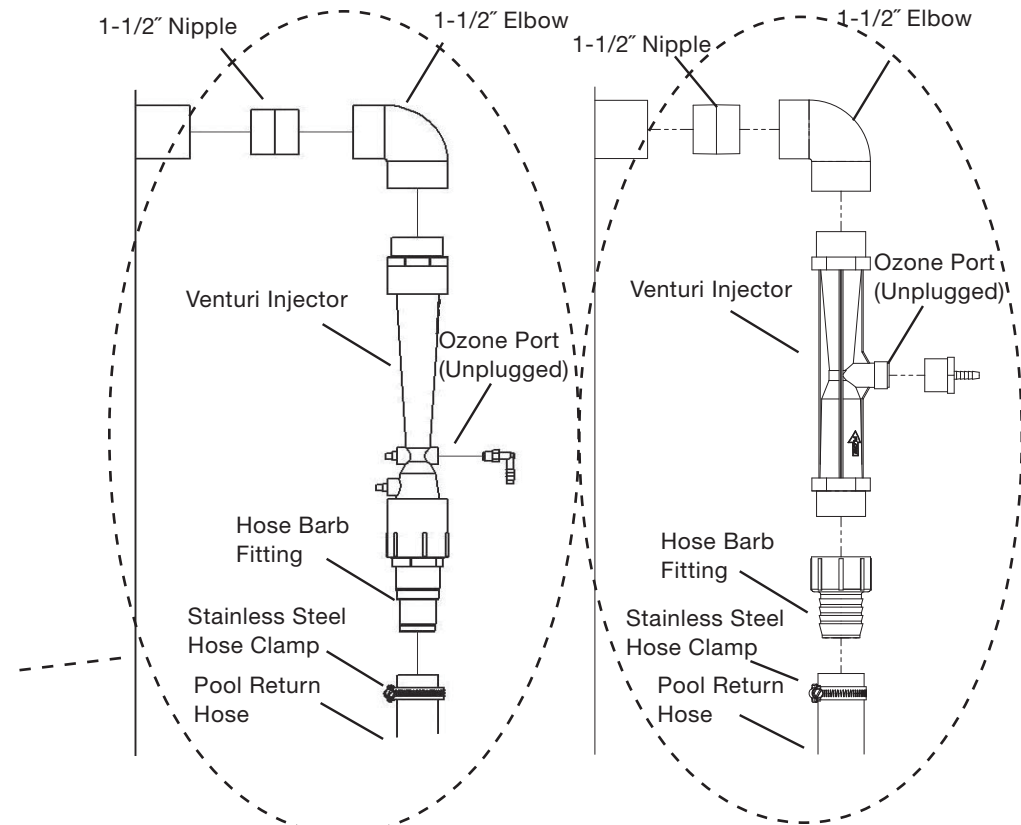

Figure 2a
Injector Assembly
Exploded View

Figure 2b
Mazzei Injector Assembly
Exploded View

SECTION 3 Operation

3A General

To achieve optimal performance from the ozone system, the pool must be as clean as possible to start with.

1. Backwash or clean filters one day before starting the ozone generator.
2. Superchlorinate pool water using a chlorine based shock treatment.
3. Test pool chemistry and adjust pH between 7.4 and 7.6. Adjust total alkalinity between 80 and 120 ppm.
4. Run pool filtration continuously for 24 hours prior to starting ozone system.

3B Initial System Start-Up

1. Turn on pool circulation system.
2. Check for leaks.
3. Verify that ozone is being pulled into the injector by checking for bubbles at the return.

If you experience complications, see TROUBLE SHOOTING Section 4D, call 800.676.1335 or visit www.delozone.com for assistance.

3C System Shut-Down

If the system is to be shut down for an extended period disconnect the ozone generator power cord and disconnect the Ozone Gas Line from the ozone generator.

SECTION 4 Maintenance and Service

4A System Electromechanical Overview

4A-1. Internal Components: Ozone Module: Each ozone module consists of a power supply connected by two high voltage wires to an electrode.

4B System Maintenance

4B-1. Ordering Information

To locate a dealer nearest you call 1.800.676.1335 ext. 249 or visit our web site www.delozone.com

Be prepared with the following information:

- Name
- Address
- Model #
- Date Purchased

4B-2. Standard Replacement Parts List

1.	EC-AG1 & EC-AG1-25 Ozone Module	5-1308-01
2.	EC-AG2 Ozone Module	5-1307-01
3.	Module Parts Kit	9-0566
4.	Ozone Check Valve and Tubing Assembly	9-0777-01

Item 4 must be replaced once each year.

4B-3. Ozone module performance will degrade over time. Replace the ozone module after 15,000 hours of operation. (15,000 hours equals approximately 5 years for a pool system that operates 8 hours/day, every day.) See Section 4C for module replacement instructions.

4B-4. While operating, check regularly to see if bubbles are entering the pool. (if you have installed an MDV, check the MDV for bubbles.)

4B-5. Regularly inspect ozone supply tubing for cracks or wear. Also check to make sure no water is present between the Check Valve and the Ozone Generator. This indicates Check Valve failure. Replace the Ozone Check Valve and Tubing Assembly (replacement part number 9-0777-01) immediately**.

****WARNING:** Trace amounts of nitric acid may be present in the check valve or tubing and could be mildly corrosive. If condensation is present, shut off ozone generator and allow the moisture to be drawn out or dried up prior to servicing.